



## High-Accuracy, 76V, High-Side Current Monitors in SOT23

MAX4007/MAX4008

### General Description

The MAX4007/MAX4008 precision, high-side, high-voltage current monitors are specifically designed for monitoring photodiode current in fiber applications. They offer a connection point for the reference current and a monitor output that produces a signal proportional to the reference current. The monitor output of the MAX4007 is a current proportional to the reference current. The monitor output of the MAX4008 is a voltage proportional to the reference current. The current monitors have six decades of dynamic range and monitor reference currents of 250nA to 2.5mA with better than 5% accuracy. The photodiode current can be monitored from 10nA to 10mA with reduced accuracy.

The MAX4007/MAX4008 accept a supply voltage of +2.7V to +76V, suitable for APD or PIN photodiode applications. Internal current limiting (20mA, typ) protects the devices against short circuit to ground. A clamp diode protects the monitor output from overvoltage. Additionally, these devices feature thermal shutdown if the die temperature reaches +150°C.

The MAX4007/MAX4008 are available in tiny, space-saving 6-pin SOT23 packages, and operate over the extended temperature range of -40°C to +85°C.

### Applications

- Photodiode Current-Monitoring Systems
- Portable Instrumentation
- Medical Instrumentation
- Laboratory Instrumentation
- Consumer Electronics
- Current-to-Voltage Conversion
- Level Translation

### Selector Guide

PART	PIN-PACKAGE	INTERNAL RESISTOR	TYPICAL ACCURACY (%)
MAX4007EUT-T	6 SOT23-6	None	5
MAX4008EUT-T	6 SOT23-6	10kΩ	1

Typical Operating Circuit appears at end of data sheet.

### Features

- ◆ Wide Reference Current Dynamic Range  
Guaranteed 250nA to 2.5mA with 5% Monitor Accuracy  
Extended 10nA to 10mA with 10% Monitor Accuracy
- ◆ Current (MAX4007) or Voltage (MAX4008) Monitor Outputs
- ◆ Reference Current-Limit Protection (20mA, typ)
- ◆ Voltage Clamp Protects Subsequent Output Circuitry
- ◆ +2.7V to +76V Wide Voltage Range Operation
- ◆ 6-Pin SOT23 Packages

### Ordering Information

PART	TEMP RANGE	PIN-PACKAGE	TOP MARK
MAX4007EUT-T	-40°C to +85°C	6 SOT23-6	ABNM
MAX4008EUT-T	-40°C to +85°C	6 SOT23-6	ABNO

### Pin Configuration

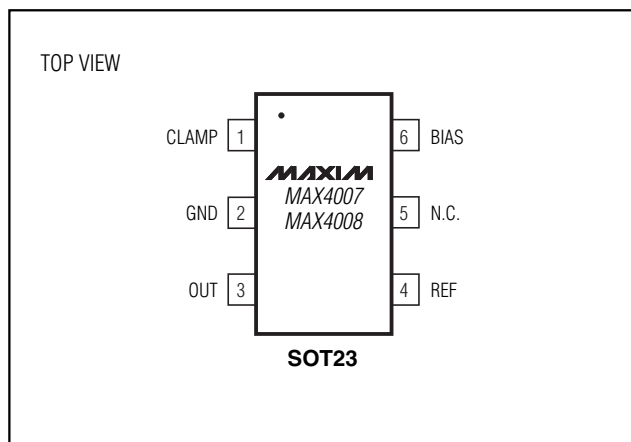

# High-Accuracy, 76V, High-Side Current Monitors in SOT23

## ABSOLUTE MAXIMUM RATINGS

CLAMP to GND .....	-0.3V to +80V
BIAS, REF to GND .....	-0.3V to +80V
OUT to GND .....	-0.3V to (V <sub>CLAMP</sub> + 0.6V)
Short Circuit, REF to GND .....	Continuous
Current into Any Pin .....	±30mA
Continuous Power Dissipation (T <sub>A</sub> = +70°C)	
6-Pin SOT23 (derate 8.7mW/°C above +70°C) .....	696mW

Operating Temperature Range .....	-40°C to +85°C
Junction Temperature .....	+150°C
Storage Temperature Range .....	-65°C to +150°C
Lead Temperature (soldering, 10s) .....	+300°C

Stresses beyond those listed under "Absolute Maximum Ratings" may cause permanent damage to the device. These are stress ratings only, and functional operation of the device at these or any other conditions beyond those indicated in the operational sections of the specifications is not implied. Exposure to absolute maximum rating conditions for extended periods may affect device reliability.

## ELECTRICAL CHARACTERISTICS

(V<sub>BIAS</sub> = 40V, GND = 0V, REF = open, V<sub>OUT</sub> = 0V (MAX4007), CLAMP = open, -40°C to +85°C. Typical values are at T<sub>A</sub> = +25°C, unless otherwise noted.) (Note 1)

PARAMETER	SYMBOL	CONDITIONS	MIN	TYP	MAX	UNITS
Bias Voltage Range	V <sub>BIAS</sub>	Inferred from power-supply rejection test	2.7		76	V
Bias Quiescent Current	I <sub>BIAS</sub>	I <sub>REF</sub> = 250nA		90	200	μA
		I <sub>REF</sub> = 2.5mA		3.6	4	mA
Reference Voltage	V <sub>REF</sub>	I <sub>REF</sub> = 2.5mA	V <sub>BIAS</sub> - 1.1	V <sub>BIAS</sub> - 0.8		V
Thermal Shutdown Engage Temperature	T <sub>SHDN</sub>	REF shorted to GND, junction temperature rising		150		°C
Trip-Point Temperature Hysteresis	T <sub>HYS</sub>	REF shorted to GND, junction temperature falling		5		°C
Input Current Limit	I <sub>LIM</sub>	V <sub>REF</sub> = V <sub>BIAS</sub> - 5V		20		mA
MAX4007 Output Current Noise	i <sub>INOUT</sub>	f = 0.1Hz to 10Hz	I <sub>REF</sub> = 250nA	0.3		pA <sub>RMS</sub>
			I <sub>REF</sub> = 2.5mA	63		
		f = 0.1Hz to 10kHz	I <sub>REF</sub> = 250nA	9.2		
			I <sub>REF</sub> = 2.5mA	1240		
MAX4008 Output Voltage Noise	e <sub>NOUT</sub>	f = 0.1Hz to 10Hz	I <sub>REF</sub> = 250nA	0.041		μV <sub>RMS</sub>
			I <sub>REF</sub> = 2.5mA	0.63		
		f = 0.1Hz to 10kHz	I <sub>REF</sub> = 250nA	1.3		
			I <sub>REF</sub> = 2.5mA	12.5		
Output Resistance	R <sub>OUT</sub>	MAX4007	I <sub>REF</sub> = 250nA	50		GΩ
			I <sub>REF</sub> = 2.5mA	5		MΩ
		MAX4008		10		kΩ
Output Leakage		REF = open		1		pA
Output Voltage Range	V <sub>OUT</sub>	V <sub>BIAS</sub> = 2.7V to 76V, I <sub>REF</sub> = 0 to 1mA, MAX4007: ΔI <sub>OUT</sub> /I <sub>OUT</sub> = ±1%, MAX4008: ΔV <sub>OUT</sub> /I <sub>OUT</sub> = ±1%	0 to V <sub>BIAS</sub> - 1.5	0 to V <sub>BIAS</sub> - 0.85		V
Output Clamp Voltage	V <sub>OUT</sub> - V <sub>CLAMP</sub>			0.6		V

# High-Accuracy, 76V, High-Side Current Monitors in SOT23

MAX4007/MAX4008

## ELECTRICAL CHARACTERISTICS (continued)

( $V_{BIAS} = 40V$ ,  $GND = 0V$ ,  $REF = open$ ,  $V_{OUT} = 0V$  (MAX4007),  $CLAMP = open$ ,  $-40^{\circ}C$  to  $+85^{\circ}C$ . Typical values are at  $T_A = +25^{\circ}C$ , unless otherwise noted.) (Note 1)

PARAMETER	SYMBOL	CONDITIONS		MIN	TYP	MAX	UNITS
Output Clamp Leakage		$V_{CLAMP} = 0$ to $76V$			1		pA
MAX4007 Current Gain	$I_{OUT}/I_{REF}$	$I_{REF} = 250nA$		0.09	0.0999	0.11	mA/mA
		$I_{REF} = 2.5mA$		0.094	0.095	0.106	
		$I_{REF} = 10mA$ , $V_{BIAS} = 12V$			0.0997		
MAX4008 Transimpedance Gain	$V_{OUT}/I_{REF}$	$I_{REF} = 250nA$		0.9	0.992	1.1	V/mA
		$I_{REF} = 2.5mA$		0.95	0.998	1.05	
		$I_{REF} = 10mA$ , $V_{BIAS} = 12V$			1.00		
Power-Supply Rejection Ratio (PSRR)	$(\Delta I_{OUT}/I_{OUT})/\Delta V_{BIAS}$	MAX4007: $V_{BIAS} = 2.7V$ to $76V$	$I_{REF} = 250nA$		50	1000	ppm/V
			$I_{REF} = 1mA$		50	1000	
	$(\Delta V_{OUT}/V_{OUT})/\Delta V_{BIAS}$	MAX4008: $V_{BIAS} = 2.7V$ to $76V$	$I_{REF} = 1mA$		50	1000	
Power-Up Settling Time	$t_s$	$I_{OUT}$ settles within 0.1%, $C_{IN} = 10nF$ between REF and GND	$I_{REF} = 250nA$		7.5		ms
			$I_{REF} = 2.5mA$		90		$\mu s$

**Note 1:** All devices are 100% tested at room temperature ( $T_A = +25^{\circ}C$ ). All temperature limits are guaranteed by design.

# High-Accuracy, 76V, High-Side Current Monitors in SOT23

## Typical Operating Characteristics

( $T_A = +25^\circ\text{C}$ , unless otherwise noted.)

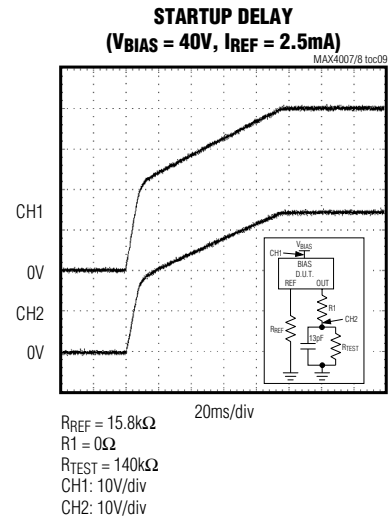
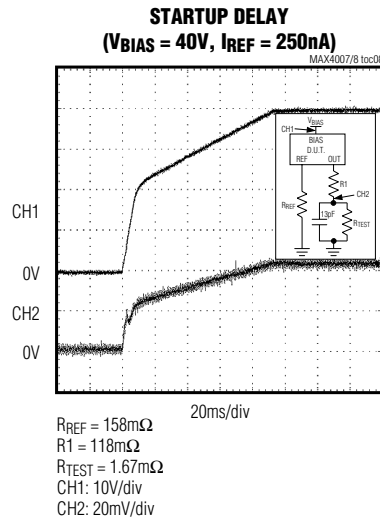
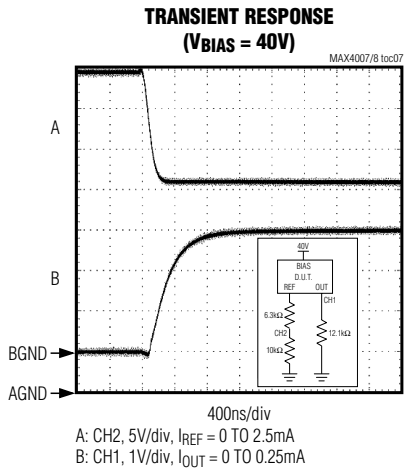
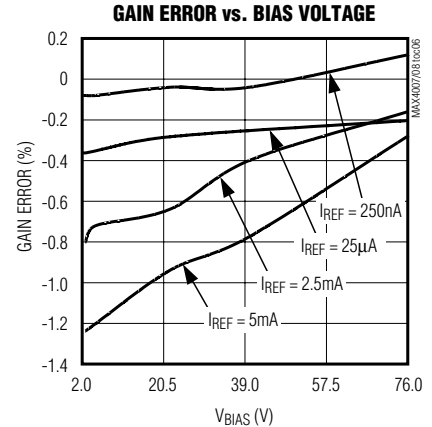
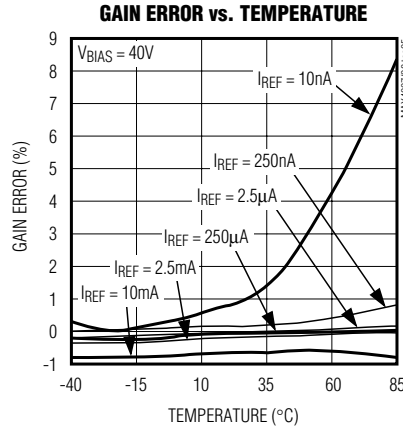
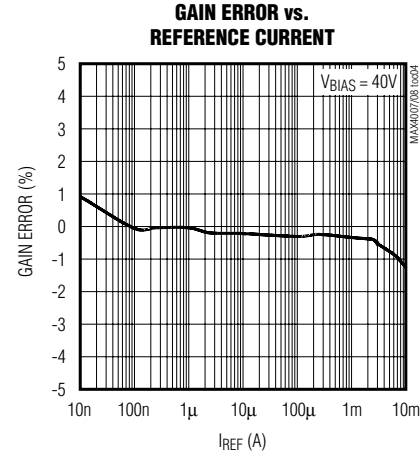
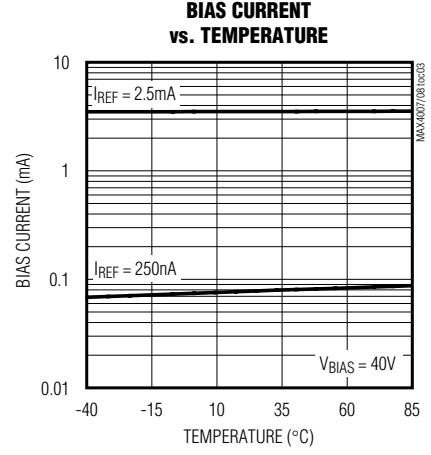
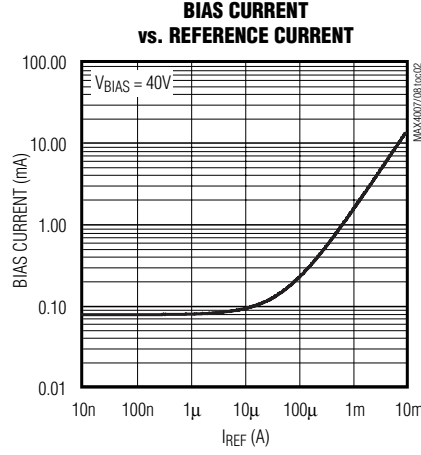
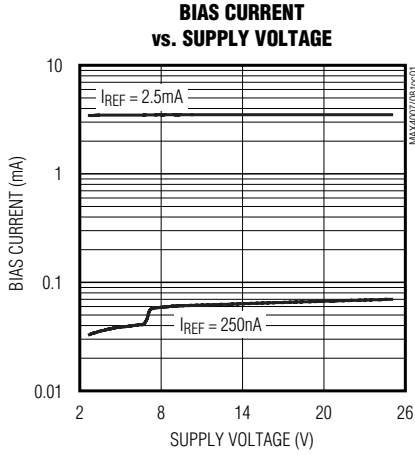

# High-Accuracy, 76V, High-Side Current Monitors in SOT23

## Typical Operating Characteristics (continued)

( $T_A = +25^\circ\text{C}$ , unless otherwise noted.)

MAX4007/MAX4008

**STARTUP DELAY**  
( $V_{BIAS} = 5\text{V}$ ,  $I_{REF} = 250\text{nA}$ )

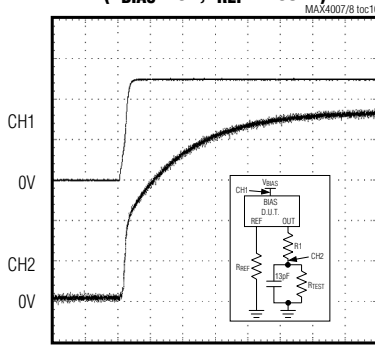

40ms/div  
 $R_{REF} = 16.8\text{m}\Omega$   
 $R1 = 118\text{m}\Omega$   
 $R_{TEST} = 1.67\text{m}\Omega$   
CH1: 2V/div  
CH2: 10V/div

**STARTUP DELAY**  
( $V_{BIAS} = 5\text{V}$ ,  $I_{REF} = 2.5\text{mA}$ )

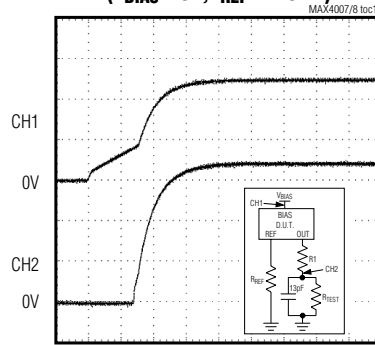

4ms/div  
 $R_{REF} = 1.68\text{k}\Omega$   
 $R1 = 0\Omega$   
 $R_{TEST} = 14.0\text{k}\Omega$   
CH1: 2V/div  
CH2: 1V/div

**SHORT-CIRCUIT RESPONSE**  
( $V_{BIAS} = 40\text{V}$ )

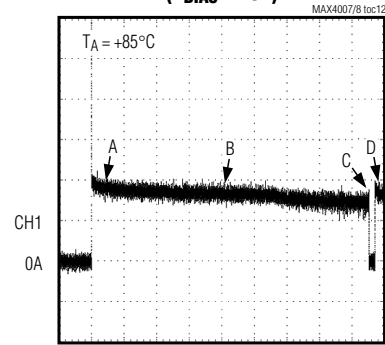

20ms/div  
CH1:  $I_{BIAS}$ , 10.0mA/div  
A: REF SHORTS TO GND  
B: CURRENT LIMIT ACTIVE  
C: THERMAL SHUTDOWN  
D: POST COOL-DOWN RETRY

**SHORT-CIRCUIT RESPONSE**  
( $V_{BIAS} = 76\text{V}$ )

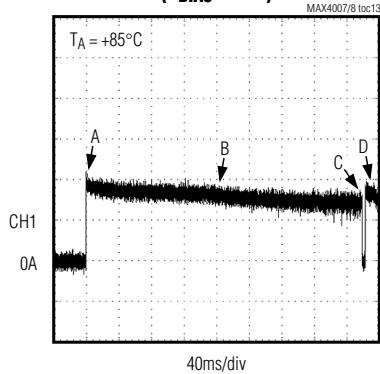

40ms/div  
CH1:  $I_{BIAS}$ , 10.0mA/div  
A: REF SHORTS TO GND  
B: CURRENT LIMIT ACTIVE  
C: THERMAL SHUTDOWN  
D: POST COOL-DOWN RETRY

**VOLTAGE DROP**  
vs. REFERENCE CURRENT

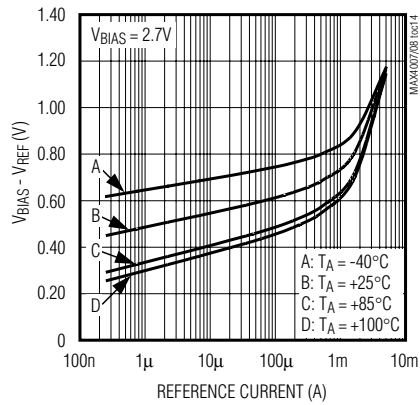

# High-Accuracy, 76V, High-Side Current Monitors in SOT23

## Pin Description

PIN		NAME	FUNCTION
MAX4007	MAX4008		
1	1	CLAMP	Clamp Voltage Input. External potential used for voltage clamping of $V_{OUT}$ .
2	2	GND	Ground
3	—	OUT	Current-Monitor Output. OUT sources a current of 1/10th $I_{REF}$ .
4	4	REF	Reference Current Output. REF provides the source current to the cathode of the photodiode.
5	5	N.C.	No Connection. Not internally connected.
6	6	BIAS	Bias Voltage Input. Bias voltage for photodiode.
—	3	OUT	Current-Monitor Output. OUT presents a voltage proportional to $I_{REF}$ at 1V/mA. An internal 10k $\Omega$ resistor connects OUT to GND (see <i>Functional Diagram</i> ).

## Functional Diagrams

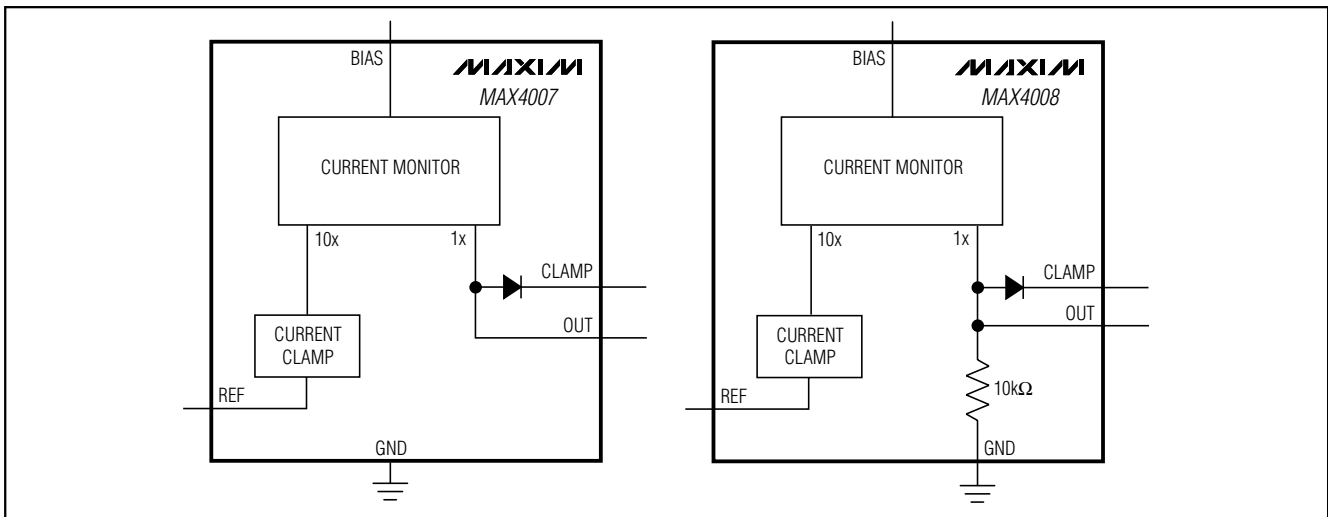

## Detailed Description

The MAX4007/MAX4008 are versatile current monitors intended for monitoring DC photodiode current in fiber applications (see *Functional Diagram*). The MAX4007 output is a current that is exactly one-tenth the reference current. The MAX4008 outputs a voltage that is proportional to the reference current with a transimpedance gain of 1V/mA achieved by a factory-trimmed, internal 10k $\Omega$  resistor.

Both current devices have six decades of dynamic range and monitor reference current ranging from 250nA to 2.5mA, the nominal operating range, with better than 5% accuracy across the entire reference current, bias voltage, and temperature ranges. The corresponding monitor outputs produce 25nA to 0.25mA (MAX4007) and 0.25mV to 2.5V (MAX4008). When the reference currents are extended to the broader range of 10nA to 10mA, an accuracy of less than 10% is maintained. Internal current limiting (20mA,

# High-Accuracy, 76V, High-Side Current Monitors in SOT23

MAX4007/MAX4008

typ) protects the device against short-circuit-to-ground conditions, and a thermal shutdown feature reduces both the reference current and the monitor current to zero if the die temperature reaches +150°C.

The MAX4007/MAX4008 accept a supply voltage of +2.7V to +76V, suitable for APD photodiode applications. A clamping diode, shown in the *Functional Diagram*, is provided to protect subsequent output circuitry from an overvoltage condition.

## Applications Information

### Clamping the Monitor Output Voltage

CLAMP provides a means for diode clamping the voltage at OUT; thus,  $V_{OUT}$  is limited to  $V_{CLAMP} + 0.6V$ . CLAMP can be connected to either an external supply, to BIAS, or may be left floating if voltage clamping is not required.

### Using APD or PIN Photodiodes in Fiber Applications

When using the MAX4007/MAX4008 to monitor APD or PIN photodiode currents in fiber applications, several issues must be addressed. In applications where the photodiode must be fully depleted, keep track of voltages budgeted for each component with respect to the available supply voltage(s). The current monitors require as much as 1.1V between BIAS and REF, which must be considered part of the overall voltage budget.

Additional voltage margin can be created if a negative supply is used in place of a ground connection, as long as the overall voltage drop experienced by the MAX4007/MAX4008 is less than or equal to 76V. For this type of application, the MAX4007 is suggested so the output can be referenced to “true” ground and not the negative supply. The MAX4007’s output current can be referenced as desired with either a resistor to ground or a transimpedance amplifier. Take care to ensure that output voltage excursions do not interfere with the required margin between BIAS and OUT. In many fiber applications, OUT is connected directly to an ADC that operates from a supply voltage that is less than the voltage at BIAS. Connecting the MAX4007/MAX4008s’ clamping diode output, CLAMP, to the ADC power supply helps avoid damage to the ADC. Without this protection, voltages can develop at OUT that might destroy the ADC. This protection is less critical when OUT is connected directly to subsequent transimpedance amplifiers (linear or logarithmic) that have low-impedance, near-ground-referenced inputs. If a transimpedance amp is used on the low side of the

photodiode, its voltage drop must also be considered. Leakage from the clamping diode is most often insignificant over nominal operating conditions, but grows with temperature.

To maintain low levels of wideband noise, lowpass filtering the output signal is suggested in applications where only DC measurements are required. Determining the required filtering components is straightforward, as the MAX4007 exhibits a very high output impedance ( $>5M\Omega$ ), while the MAX4008 exhibits an output resistance of  $10k\Omega$ .

In some applications where pilot tones are used to identify specific fiber channels, higher bandwidths are desired at OUT to detect these tones. Consider the minimum and maximum currents to be detected, then consult the frequency response and noise typical operating curves. If the minimum current is too small, insufficient bandwidth could result, while too high a current could result in excessive noise across the desired bandwidth. Refer to the MAX4009 family data sheet for devices intended for fiber applications using pilot tones.

### Bypassing and External Components

In applications where power-supply noise can interfere with DC diode measurements, additional filtering is suggested. Such noise is commonly seen when switching power supplies are used to generate the photodiode bias voltage. As shown in the *Typical Operating Circuit*, a pi filter (two  $0.22\mu F$  capacitors and one  $2.2\mu H$  inductor) greatly suppresses power-supply switching noise. If such a filter is already present in the bias generating circuit, only a simple bypass capacitor at the BIAS pin is suggested. The output lowpass filter, a  $10k\Omega$  resistor and a  $10nF$  capacitor, further reduce permeating power-supply noise, as well as other wideband noise that might otherwise restrict measurements at low-signal levels. Again, reducing the bandwidth of the OUT signal can affect performance of pilot-tone systems.

To restrict high-frequency photodiode signals from affecting the current monitors and BIAS power supply, an RF choke and  $10nF$  capacitor can be added. The capacitance presented to REF should not exceed  $10nF$ ; larger values increase startup time and could cause the thermal shutdown circuit to activate during startup.

# High-Accuracy, 76V, High-Side Current Monitors in SOT23

## Typical Operating Circuit

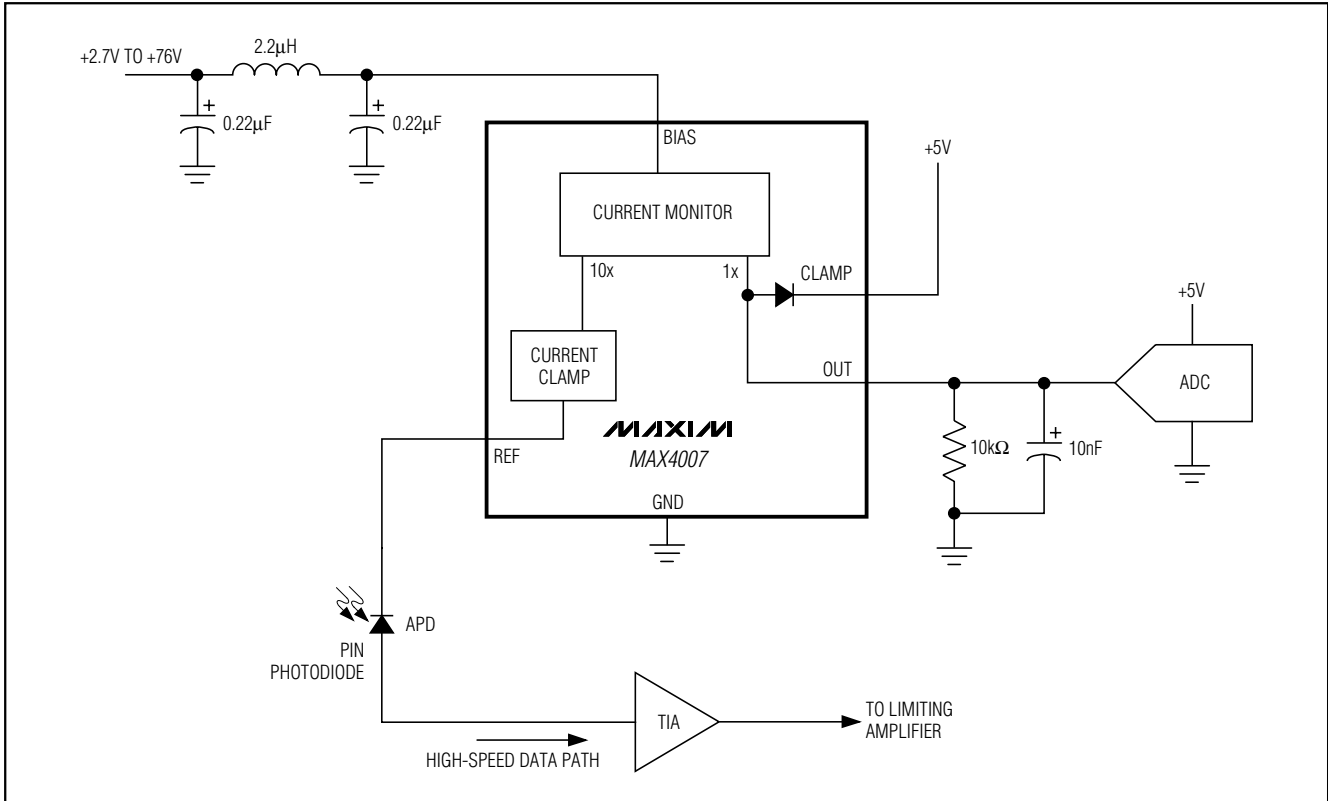

## Chip Information

TRANSISTOR COUNT: 195  
 PROCESS: BiCMOS



# High-Accuracy, 76V, High-Side Current Monitors in SOT23

## Package Information

(The package drawing(s) in this data sheet may not reflect the most current specifications. For the latest package outline information go to [www.maxim-ic.com/packages](http://www.maxim-ic.com/packages).)

MAX4007/MAX4008

SYMBOL	MIN	MAX
A	0.90	1.45
A1	0.00	0.15
A2	0.90	1.30
b	0.35	0.50
C	0.08	0.20
D	2.80	3.00
E	2.60	3.00
E1	1.50	1.75
L	0.35	0.60
L1	0.60	REF.
e1	1.90	BSC.
e	0.95	BSC.
$\alpha$	0°	10°

**NOTES:**

- ALL DIMENSIONS ARE IN MILLIMETERS.
- FOOT LENGTH MEASURED AT INTERCEPT POINT BETWEEN DATUM A & LEAD SURFACE.
- PACKAGE OUTLINE EXCLUSIVE OF MOLD FLASH & METAL BURR. MOLD FLASH, PROTRUSION OR METAL BURR SHOULD NOT EXCEED 0.25 MM.
- PACKAGE OUTLINE INCLUSIVE OF SOLDER PLATING.
- PIN 1 IS LOWER LEFT PIN WHEN READING TOP MARK FROM LEFT TO RIGHT. (SEE EXAMPLE TOP MARK)
- PIN 1 I.D. DOT IS 0.3 MM  $\phi$  MIN. LOCATED ABOVE PIN 1.
- MEETS JEDEC MO178, VARIATION AB.
- SOLDER THICKNESS MEASURED AT FLAT SECTION OF LEAD BETWEEN 0.08mm AND 0.15mm FROM LEAD TIP.
- LEAD TO BE COPLANAR WITHIN 0.1 MM.

**DALLAS SEMICONDUCTOR** **MAXIM**  
 PROPRIETARY INFORMATION  
 TITLE: PACKAGE OUTLINE, SOT-23, 6L  
 APPROVAL: \_\_\_\_\_ DOCUMENT CONTROL NO. 21-0058 REV. F 1/1

Maxim cannot assume responsibility for use of any circuitry other than circuitry entirely embodied in a Maxim product. No circuit patent licenses are implied. Maxim reserves the right to change the circuitry and specifications without notice at any time.

Maxim Integrated Products, 120 San Gabriel Drive, Sunnyvale, CA 94086 408-737-7600 \_\_\_\_\_ 9